

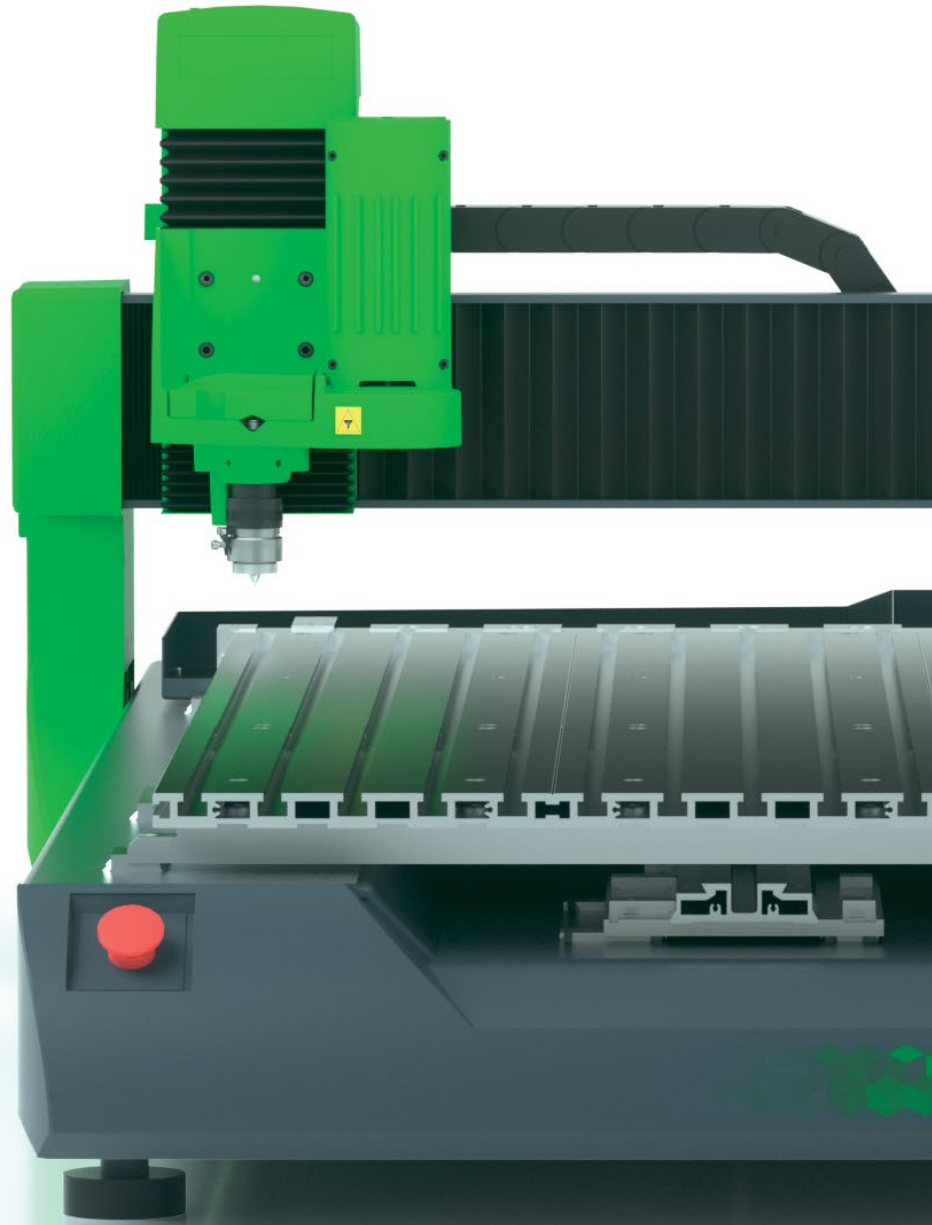

CNC STATION

ISX000



GRAVOTECH
EXPRESSION OF THINGS



Fast, powerful, and precise: discover a machine unique in the market. The ISx000 range is designed for large format jobs to batch engraving and cutting.

CNC STATION
ISX000

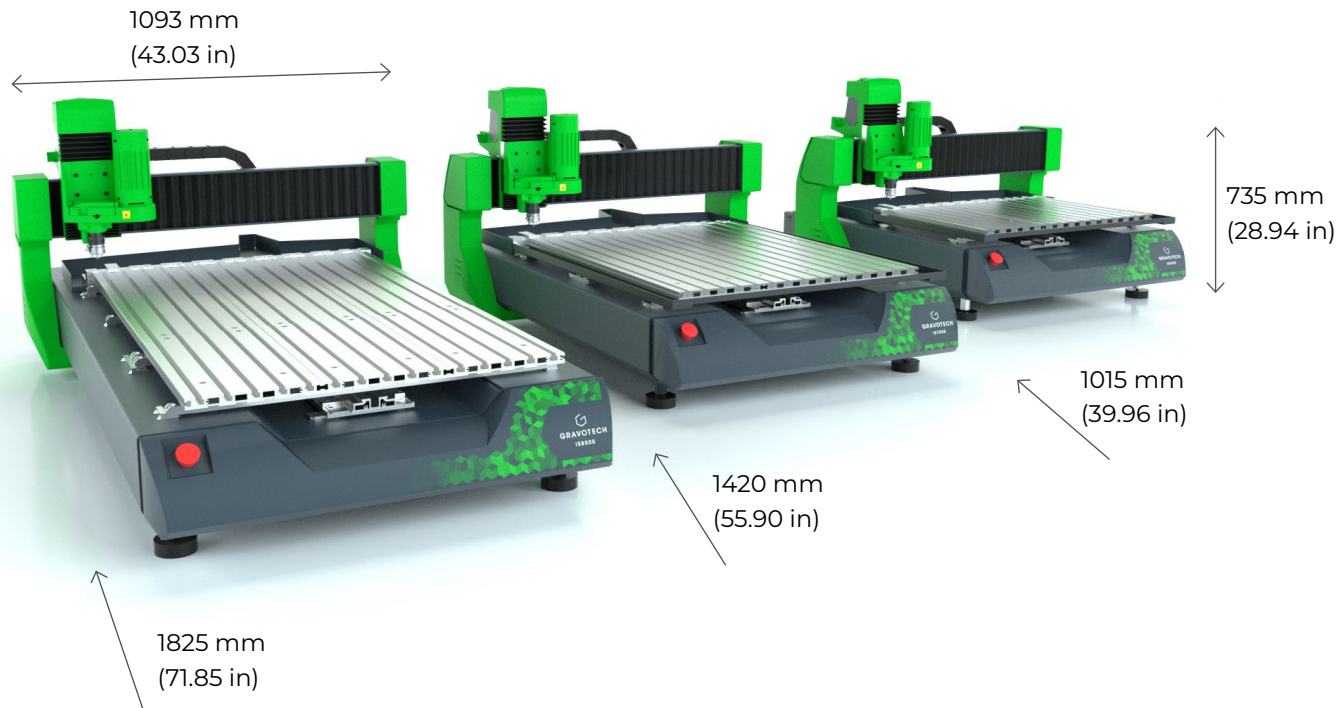

HIGH-PERFORMANCE

Developed from a monobloc structure the ISx000 range is a solid workhorse. A choice between 4 high frequency motors means that you will be working with the highest performance whatever the material or its thickness.

VALUE FOR MONEY

These large format engraving machines makes high volume jobs quicker and easier, The ISx000 range remains unrivalled on the ratio, price per working area, on the market. Once you have set up the job on Gravostyle, you can trust the machine to do the task in all safety without your constant supervision.

ADAPTABLE

3 different sizes, 2 motorized axis (stepper or brushless motors) and a large range of accessories. Light and deep engraving, batch labelling, drilling, and 2.5 milling (hot iron) the ISx000 range is versatile enough to be used in most industrial applications.

SEE OUR VIDEO



The large format CNC engraving machine

KEY FEATURES

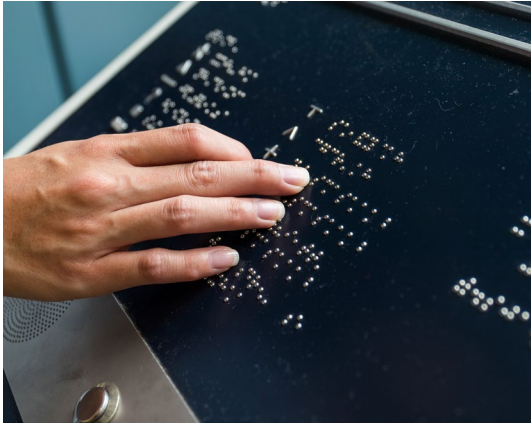

ADA and braille sign engraving machine

With our ADA compliant braille solution, the ISx000 range becomes the sign maker machine.

From Gravostyle™ transcribing text to braille, the machine drills the plates and lays the beads automatically.

The process is simple, hassle free and braille certified.



Batch Engrave For High Productivity

The large marking area is designed to both engrave big items, one by one or to do batches of hundreds of smaller items at one time;

use the Stamp Mode to engrave different designs, use the Matrix Mode to duplicate patterns on labels.

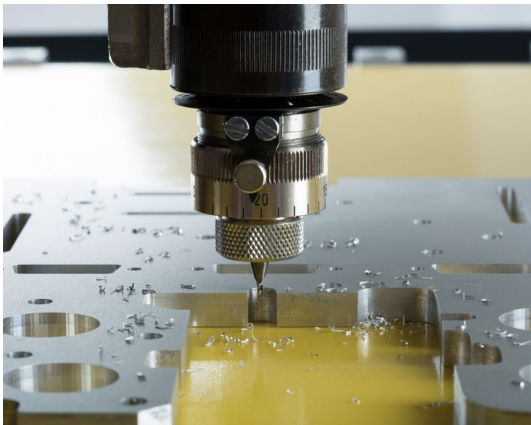

2,5 D engraving and drilling

Be it for hot stamp, insert manufacturing and even anti-counterfeit deep marking firearms, the ISx000 range will become your go to solution.

Harder metals can be processed by adding a lubrication kit, powerful spindle and the right cutting tools.

LEARN MORE ABOUT THE ISX000



APPLICATIONS

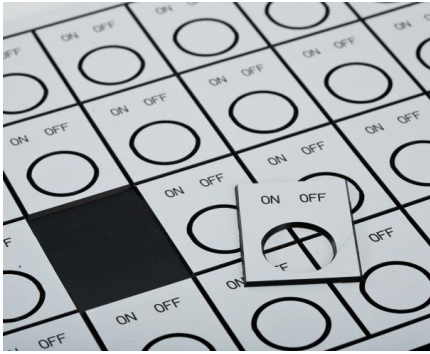

Badges, tags engraving & cutting

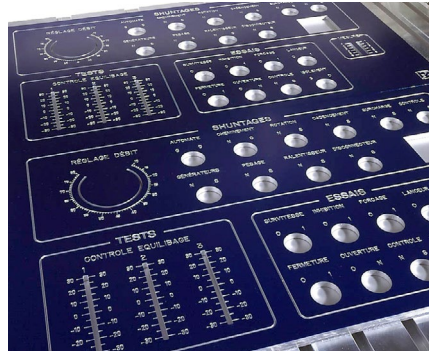

Front panel

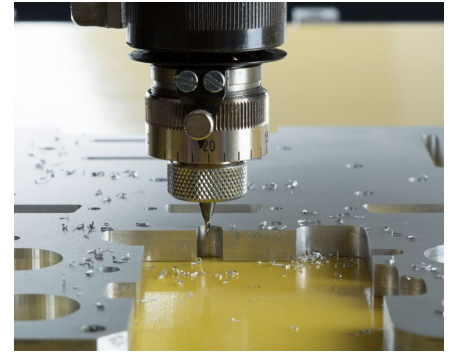

Industrial milling & deep engraving



Braille ADA

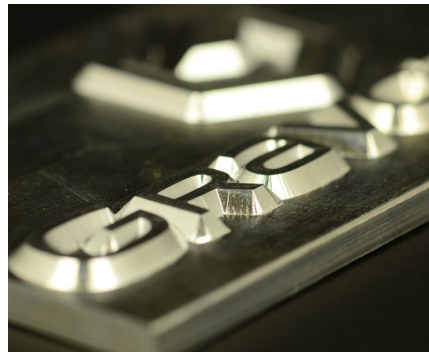

2.5 D



Large letters cutting - Signage

MATERIAL CHARACTERISTICS

ROTARY

SCRIBING/DIAMOND

Materials		ROTARY	SCRIBING/DIAMOND
Wood		◀▶	
Glass, crystal		◆	
Leather		◀▶	
Stone, granite, marble		◻	
Food		◆	
Ceramic		◆	
Plastics		◀▶	◆
Metal		◀▶	◆

Cutting = ◀▶ Engraving / Deep marking = ◻ Marking / Etching = ◆

MAKE YOUR SAMPLES



SOFTWARE

GRAVOSTYLE™



Expert software made by engravers for engravers

Gravostyle™ is a professional engraving and cutting software that puts Gravotech engraving expertise in reach. Benefit from advanced possibilities and save time! Unique features available: Braille, Photostyle, Print & Cut, and more.

Complete engraving process mastered

Due to our history of making engraving machines, we have a full understanding of the engraving process. Gravostyle™ is fully compatible with all of our technologies. The software/machine interaction streamlines and improves your day-to-day engravings with functions like Point & Shoot.

Gravostyle™: unique software for laser and rotary

Are you already using Gravostyle™ on your rotary machine, and expanding your business with a laser? No need to learn how to use another software, switch in one click on the Gravostyle™ interface to set-up laser engraving!

SERVICE & SUPPORT



Training

Our training modules are designed to optimize your use of our solutions and are available for our full range of machines, software and accessories.



Technical support

We bring you local support in your language in more than 50 countries, where we have established presence directly and with our distribution partners.



Maintenance

Thanks to experience gathered with Gravograph and Technifor and our global presence in more than 50 countries with 150 Gravotech technicians and our distributor partners, we can offer you a wide range of services.

TECHNICAL DATA

	IS6000	IS7000	IS8000
Technology	Rotary, scribing		
Marking area max (L x H)	610 x 410 mm (24 x 16 in)	610 x 815 mm (24 x 32 in)	610 x 1220 mm (24 x 48 in)
Max object size	Unlimited x unlimited x 80 mm (3,15 in)		
Max object weight	40Kg - 88,2 lbs		
Dimensions (L x W x H)	1093 x 1015 x 735 mm (43 x 40 x 29 in)	1093 x 1420 x 735 mm (43 x 56 x 29 in)	1093 x 1825 x 735 mm (43 x 72 x 29 in)
Machine weight	168 kg (370 lbs)	220 kg (485 lbs)	265 kg (584 lbs)
Spindle power	90W or 200 W Optional spindles : 150W, 750 W, 1kW		
Type of spindle	Top load spindle or collet spindle		
Noise	80 dB (A) +/- 2		
Point & shoot	yes		
Operating temperature	5 °C (41 °F) - 40 °C (104 °F)		
Connection to computer	USB		
Maximum speed	IQ : 25 mm/s (1 in/s) XP : 60 mm/s (2,4 in/s)		
Z stroke (Z travel)	80 mm (3,15 in)		
Max rotation speed	20 000 rpm		
Tool diameter	4,36 mm (0,2 in) With optional spindle : 3mm (0,1 in) to 6,36 mm (0,25 in)		



contact@gravotech.com
 +33 (0) 4 78 55 85 50
www.gravotech.com

GRAVOTECH MARKING
 466 rue des Mercières - Z.I. Perica
 69140 Rillieux-la-Pape France

Follow us:

